

High Performance Isolated Collector Silicon Bipolar Transistor

Technical Data

HBFP-0450

Features

- Ideal for High Performance, Medium Power, and Low Noise Applications
- Typical Performance at 1.8 GHz

Medium Power Application

P_{1dB} of 19 dBm, Noise Figure of 1.7 dB, and Associated Gain of 15 dB at 3 V and 50 mA

Low Noise Application

Noise Figure of 1.2 dB, Associated Gain of 13 dB, and P_{1dB} of 11 dBm at 2 V and 10 mA

- Miniature 4-lead SC-70 (SOT-343) Plastic Package
- Transition Frequency $f_T = 25$ GHz

4-lead SC-70 (SOT-343) Surface Mount Plastic Package

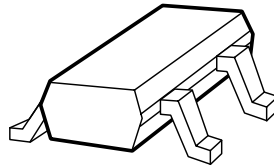

Pin Configuration

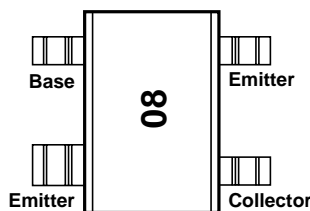

Note:
Package marking provides orientation and identification.

Description

Hewlett Packard's HBFP-0450 is a high performance isolated collector silicon bipolar junction transistor housed in a 4-lead SC-70 (SOT-343) surface mount plastic package.

This product is based on a 25 GHz transition frequency fabrication process, which enables the products to be used for high performance, medium power, low noise applications up to 6 GHz.

Applications

- Driver amplifier for *Cellular and PCS base stations*
- Driver amplifier and medium power amplifier for *Cellular and PCS handsets*
- High dynamic range LNA for *ISM, wireless data, and WLL applications*
- Oscillator, mixer, and LO Buffer applications

HBFP-0450 Absolute Maximum Ratings

Symbol	Parameter	Units	Absolute Maximum ^[1]
V_{EBO}	Emitter-Base Voltage	V	1.5
V_{CBO}	Collector-Base Voltage	V	15.0
V_{CEO}	Collector-Emitter Voltage	V	4.5
I_C	Collector Current	mA	100
P_T	Power Dissipation ^[2]	mW	450
T_j	Junction Temperature	°C	150
T_{STG}	Storage Temperature	°C	-65 to 150

Thermal Resistance:

$$\theta_{jc} = 180^{\circ}\text{C/W}$$

Notes:

1. Operation of this device above any one of these parameters may cause permanent damage.
2. P_T due to Maximum Ratings.
3. Thermal resistance measured using Liquid Crystal Measurement method.

Electrical Specifications, $T_C = 25^{\circ}\text{C}$

Symbol	Parameters and Test Conditions	Units	Min.	Typ.	Max.
DC Characteristics					
BV_{CEO}	Collector-Emitter Breakdown Voltage	$I_C = 1 \text{ mA}$, open base	V	4.5	
I_{CBO}	Collector-Cutoff Current	$V_{CB} = 5 \text{ V}$, $I_E = 0$	nA		500
I_{EBO}	Emitter-Base Cutoff Current	$V_{EB} = 1.5 \text{ V}$, $I_C = 0$	μA		100
h_{FE}	DC Current Gain	$V_{CE} = 2 \text{ V}$, $I_C = 20 \text{ mA}$	—	50	80
RF Characteristics					
$P_{-1\text{dB}}$	Power Output at 1 dB Compression Point	$I_C = 50 \text{ mA}$, $V_{CE} = 3 \text{ V}$, $f = 1.8 \text{ GHz}$ $I_C = 50 \text{ mA}$, $V_{CE} = 2 \text{ V}$, $f = 1.8 \text{ GHz}$	dBm	19 17	
IP_3	3 rd Order Intercept Pt at Output	$I_C = 50 \text{ mA}$, $V_{CE} = 3 \text{ V}$, $f = 1.8 \text{ GHz}$	dBm	29	
$G_{-1\text{dB}}$	Gain at 1 dB Compression Point	$I_C = 50 \text{ mA}$, $V_{CE} = 3 \text{ V}$, $f = 1.8 \text{ GHz}$ $I_C = 50 \text{ mA}$, $V_{CE} = 2 \text{ V}$, $f = 1.8 \text{ GHz}$	dBm	16 15.5	
F_{MIN}	Minimum Noise Figure	$I_C = 50 \text{ mA}$, $V_{CE} = 3 \text{ V}$, $f = 1.8 \text{ GHz}$ $I_C = 50 \text{ mA}$, $V_{CE} = 2 \text{ V}$, $f = 1.8 \text{ GHz}$	dB	1.7 1.8	
G_a	Associated Gain	$I_C = 50 \text{ mA}$, $V_{CE} = 3 \text{ V}$, $f = 1.8 \text{ GHz}$ $I_C = 50 \text{ mA}$, $V_{CE} = 2 \text{ V}$, $f = 1.8 \text{ GHz}$	dB	15 14.5	
NF	Minimum Noise Figure	$I_C = 10 \text{ mA}$, $V_{CE} = 2 \text{ V}$, $f = 1.8 \text{ GHz}$ $I_C = 20 \text{ mA}$, $V_{CE} = 2 \text{ V}$, $f = 1.8 \text{ GHz}$	dB	1.2 1.3	1.7
G_a	Associated Gain	$I_C = 10 \text{ mA}$, $V_{CE} = 2 \text{ V}$, $f = 1.8 \text{ GHz}$ $I_C = 20 \text{ mA}$, $V_{CE} = 2 \text{ V}$, $f = 1.8 \text{ GHz}$	dB	13.0	13 14
$P_{-1\text{dB}}$	Power Output at 1 dB Compression Point	$I_C = 10 \text{ mA}$, $V_{CE} = 2 \text{ V}$, $f = 1.8 \text{ GHz}$ $I_C = 20 \text{ mA}$, $V_{CE} = 2 \text{ V}$, $f = 1.8 \text{ GHz}$	dBm	11 14	

HBFP-0450 Typical Performance

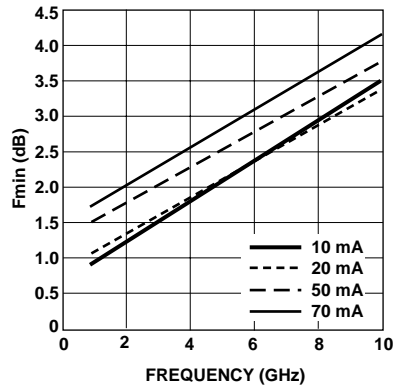

Figure 1. Minimum Noise Figure vs. Frequency and Collector Current at 2 V.

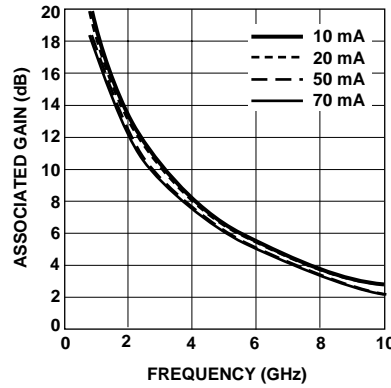

Figure 2. Associated Gain vs. Frequency and Collector Current at 2 V.

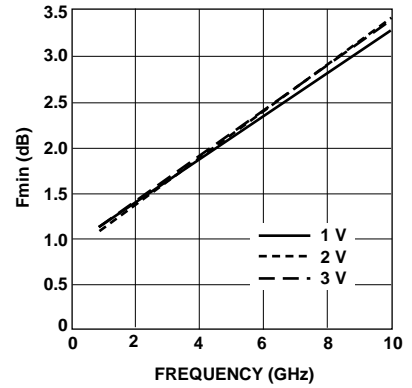

Figure 3. Minimum Noise Figure vs. Frequency and Voltage at 20 mA.

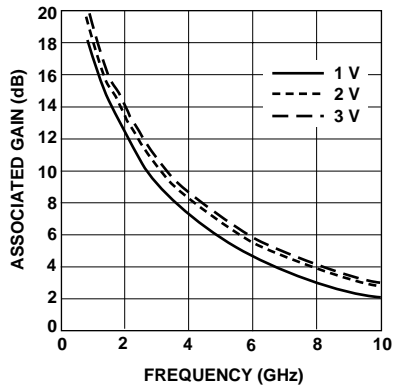

Figure 4. Associated Gain vs. Frequency and Voltage at 20 mA.

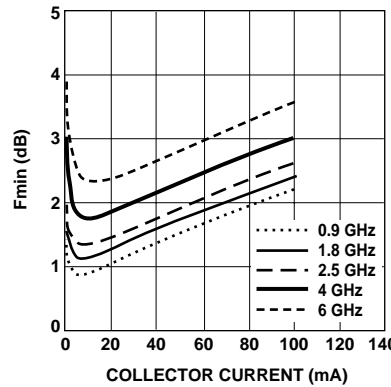

Figure 5. Minimum Noise Figure vs. Collector Current at 2 V.

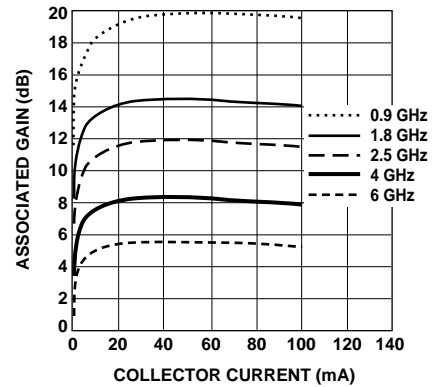

Figure 6. Associated Gain vs. Collector Current at 2 V.

HBFP-0450 Typical Performance, continued

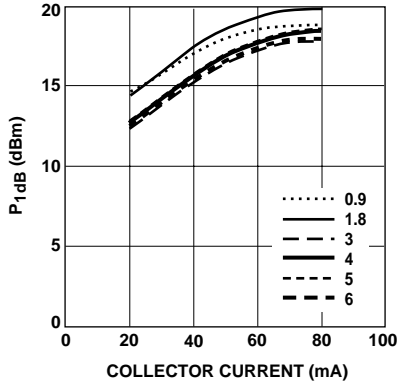

Figure 7. P_{1dB} vs. Collector Current and Frequency.

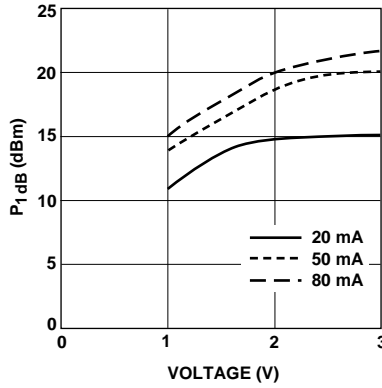

Figure 8. P_{1dB} vs. Voltage at 1.8 GHz.

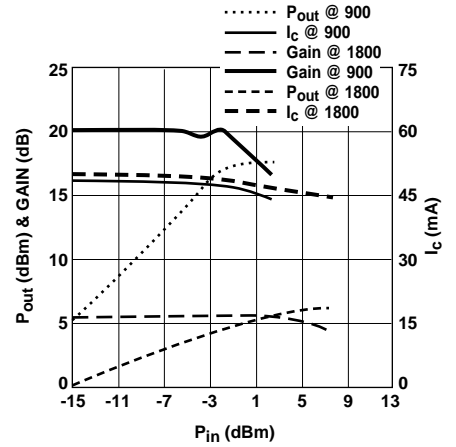

Figure 9. P_{out} (dBm), Gain (dB), and I_c (mA) vs. P_{in} (dBm) at 2 V, 50 mA.
 900 MHz: Γ_S : Mag: 0.68, Ang: 121°; Γ_L : Mag: 0.38, Ang: 171°
 1800 MHz: Γ_S : Mag: 0.44, Ang: 158°; Γ_L : Mag: 0.28, Ang: 159°

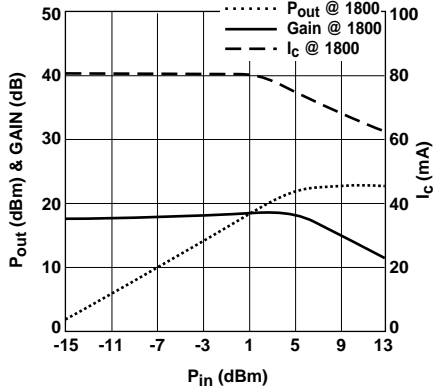

Figure 10. P_{out} (dBm), Gain (dB), and I_c (mA) vs. P_{in} (dBm) at 3 V, 80 mA.
 Γ_S : Mag: 0.72, Ang: 169°
 Γ_L : Mag: 0.26, Ang: 168°

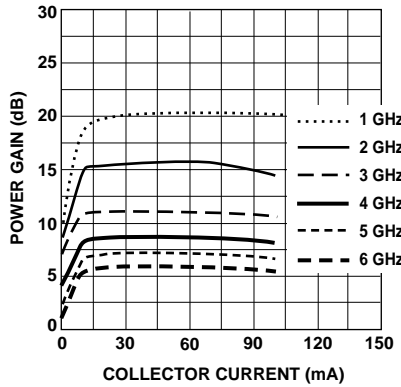

Figure 11. Power Gain vs. Collector Current and Frequency at 2V.

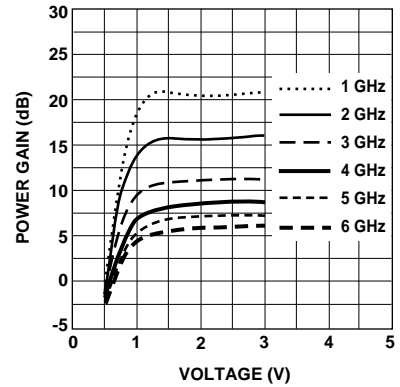

Figure 12. Power Gain vs. Voltage and Frequency at 50 mA.

HBFP-0450 Typical Scattering Parameters,

$V_{CE} = 2\text{ V}$, $I_C = 10\text{ mA}$

Freq. GHz	S_{11}		S_{21}			S_{12}			S_{22}	
	Mag	Ang	dB	Mag	Ang	dB	Mag	Ang	Mag	Ang
0.1	0.74	-39	26.20	20.409	157	-31.37	0.027	71	0.93	-26
0.5	0.73	-128	20.68	10.813	107	-22.85	0.072	33	0.53	-90
0.9	0.71	-161	16.16	6.425	87	-21.83	0.081	24	0.37	-122
1.0	0.71	-166	15.29	5.816	83	-21.72	0.082	23	0.35	-129
1.5	0.72	175	11.85	3.913	68	-20.92	0.090	20	0.31	-154
1.8	0.73	167	10.26	3.260	60	-20.45	0.095	19	0.30	-165
2.0	0.73	162	9.37	2.941	55	-20.18	0.098	19	0.30	-172
2.5	0.74	150	7.46	2.360	44	-19.33	0.108	17	0.30	175
3.0	0.74	140	5.94	1.981	34	-18.56	0.118	15	0.30	164
4.0	0.75	120	3.67	1.526	14	-17.02	0.141	8	0.31	146
5.0	0.76	102	1.97	1.255	-5	-15.65	0.165	-2	0.33	126
6.0	0.79	83	0.47	1.055	-25	-14.70	0.184	-15	0.37	106
7.0	0.81	65	-1.00	0.891	-43	-14.07	0.198	-28	0.43	88
8.0	0.84	49	-2.33	0.765	-60	-13.64	0.208	-40	0.48	72
9.0	0.85	35	-3.47	0.671	-75	-13.19	0.219	-53	0.52	57
10.0	0.87	20	-4.45	0.599	-91	-12.84	0.228	-67	0.55	40

HBFP-0450 Noise Parameters: $V_{CE} = 2\text{ V}$, $I_C = 10\text{ mA}$

Freq. GHz	F_{min} dB	Γ_{opt}		$R_N/50$ —	G_a dB
		Mag	Ang		
0.5	0.80	0.36	124	0.24	22.7
0.9	0.91	0.38	140	0.16	18.4
1.5	1.08	0.41	160	0.08	14.7
1.8	1.15	0.46	177	0.05	13.5
2.0	1.21	0.48	-178	0.05	12.6
2.5	1.36	0.53	-162	0.06	10.9
3.0	1.51	0.59	-150	0.09	9.6
4.0	1.8	0.65	-127	0.25	7.6
5.0	2.09	0.70	-106	0.55	6.2
6.0	2.39	0.73	-85	1.09	5.0

Note: R_N represents normalized noise resistance.

S and noise parameters are measured on a microstrip line made on 0.025 inch thick alumina carrier. The input reference plane is at the end of the base lead, the output reference plane is at the end of the collector lead. S and noise parameters include the effect of four plated through via holes connecting emitter landing pads on the top of test carrier to the microstrip ground plane on the bottom side of the carrier. Two 0.020 inch diameter via holes are placed within 0.010 inch from each emitter lead contact point, one via on each side of that point.

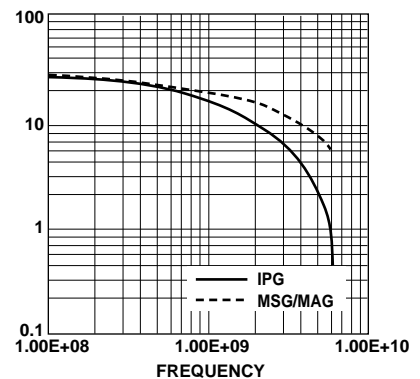

Figure 13. HBFP-0450 Power Gain at 2 V, 10 mA.

HBFP-0450 Typical Scattering Parameters,

$V_{CE} = 2 \text{ V}$, $I_C = 20 \text{ mA}$

Freq. GHz	S_{11}		S_{21}			S_{12}			S_{22}	
	Mag	Ang	dB	Mag	Ang	dB	Mag	Ang	Mag	Ang
0.1	0.64	-53	29.07	28.415	153	-32.04	0.025	67	0.89	-35
0.5	0.70	-144	21.90	12.449	101	-24.88	0.057	33	0.49	-110
0.9	0.70	-170	17.10	7.159	84	-23.61	0.066	30	0.38	-143
1.0	0.70	-174	16.20	6.455	80	-23.35	0.068	30	0.37	-149
1.5	0.71	169	12.69	4.308	67	-21.94	0.080	30	0.35	-172
1.8	0.72	162	11.09	3.584	60	-21.11	0.088	29	0.35	-179
2.0	0.73	157	10.18	3.23	55	-20.63	0.093	29	0.35	173
2.5	0.73	147	8.26	2.589	45	-19.41	0.107	26	0.36	161
3.0	0.74	137	6.73	2.171	35	-18.34	0.121	23	0.37	152
4.0	0.74	118	4.46	1.672	16	-16.48	0.150	13	0.38	134
5.0	0.76	100	2.75	1.373	-3	-15.09	0.176	1	0.39	115
6.0	0.78	82	1.23	1.152	-22	-14.11	0.197	-13	0.43	96
7.0	0.81	64	-0.23	0.974	-40	-13.60	0.209	-27	0.48	79
8.0	0.83	48	-1.54	0.838	-56	-13.23	0.218	-40	0.52	65
9.0	0.85	34	-2.64	0.738	-72	-12.88	0.227	-53	0.55	49
10.0	0.87	19	-3.58	0.662	-88	-12.58	0.235	-67	0.58	33

HBFP-0450 Noise Parameters: $V_{CE} = 2 \text{ V}$, $I_C = 20 \text{ mA}$

Freq. GHz	F_{min} dB	Γ_{opt}		$R_N/50$ —	G_a dB
		Mag	Ang		
0.5	0.97	0.33	152	0.19	24.1
0.9	1.07	0.37	165	0.13	19.6
1.0	1.10	0.38	168	0.12	18.8
1.5	1.22	0.45	-178	0.08	15.6
1.8	1.3	0.49	-167	0.06	14.3
2.0	1.34	0.50	-164	0.06	13.5
2.5	1.47	0.55	-152	0.08	11.7
3.0	1.6	0.59	-142	0.12	10.2
4.0	1.87	0.64	-121	0.29	8.1
5.0	2.12	0.68	-102	0.57	6.6
6.0	2.37	0.73	-83	1.04	5.5

Note: R_N represents normalized noise resistance.

S and noise parameters are measured on a microstrip line made on 0.025 inch thick alumina carrier. The input reference plane is at the end of the base lead, the output reference plane is at the end of the collector lead. S and noise parameters include the effect of four plated through via holes connecting emitter landing pads on the top of test carrier to the microstrip ground plane on the bottom side of the carrier. Two 0.020 inch diameter via holes are placed within 0.010 inch from each emitter lead contact point, one via on each side of that point.

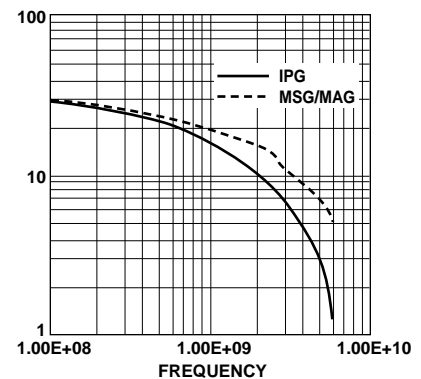

Figure 14. HBFP-0450 Power Gain at 2 V, 20 mA.

HBFP-0450 Typical Scattering Parameters,

$V_{CE} = 2\text{ V}$, $I_C = 50\text{ mA}$

Freq. GHz	S_{11}		S_{21}			S_{12}			S_{22}	
	Mag	Ang	dB	Mag	Ang	dB	Mag	Ang	Mag	Ang
0.1	0.54	-74	31.05	35.689	147	-33.15	0.022	63	0.84	-45
0.5	0.69	-156	22.41	13.198	97	-26.56	0.047	36	0.48	-128
0.9	0.70	-178	17.44	7.450	81	-24.88	0.057	37	0.42	-159
1.0	0.71	179	16.53	6.707	78	-24.44	0.060	38	0.41	-164
1.5	0.72	165	12.98	4.456	66	-22.38	0.076	38	0.41	178
1.8	0.73	158	11.38	3.705	59	-21.41	0.085	37	0.41	169
2.0	0.73	154	10.47	3.337	55	-20.72	0.092	36	0.42	164
2.5	0.74	144	8.55	2.675	45	-19.25	0.109	32	0.42	154
3.0	0.74	134	7.02	2.245	36	-18.06	0.125	28	0.43	145
4.0	0.75	116	4.76	1.730	17	-16.08	0.157	16	0.44	127
5.0	0.76	99	3.05	1.421	-1	-14.66	0.185	2	0.45	109
6.0	0.78	81	1.52	1.191	-20	-13.72	0.206	-12	0.49	90
7.0	0.81	63	0.06	1.007	-38	-13.23	0.218	-27	0.53	74
8.0	0.83	48	-1.24	0.867	-54	-12.92	0.226	-40	0.57	60
9.0	0.85	33	-2.30	0.767	-69	-12.62	0.234	-54	0.60	45
10.0	0.86	19	-3.24	0.689	-85	-12.40	0.240	-68	0.61	29

HBFP-0450 Noise Parameters: $V_{CE} = 2\text{ V}$, $I_C = 50\text{ mA}$

Freq. GHz	F_{min} dB	Γ_{opt}		$R_N/50$ —	G_a dB
		Mag	Ang		
0.5	1.46	0.43	-176	0.18	24.7
0.9	1.56	0.48	-170	0.14	20.1
1.0	1.58	0.50	-167	0.13	19.3
1.5	1.70	0.54	-160	0.10	16.1
1.8	1.78	0.58	-153	0.09	14.7
2.0	1.81	0.59	-151	0.11	13.9
2.5	1.94	0.62	-141	0.16	12.0
3.0	2.07	0.64	-133	0.23	10.6
4.0	2.31	0.68	-114	0.48	8.4
5.0	2.57	0.71	-96	0.85	6.8
6.0	2.82	0.74	-78	1.46	5.6

Note: R_N represents normalized noise resistance.

S and noise parameters are measured on a microstrip line made on 0.025 inch thick alumina carrier. The input reference plane is at the end of the base lead, the output reference plane is at the end of the collector lead. S and noise parameters include the effect of four plated through via holes connecting emitter landing pads on the top of test carrier to the microstrip ground plane on the bottom side of the carrier. Two 0.020 inch diameter via holes are placed within 0.010 inch from each emitter lead contact point, one via on each side of that point.

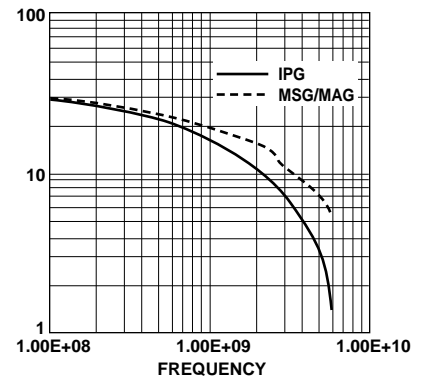

Figure 15. HBFP-0450 Power Gain at 2 V, 50 mA.

HBFP-0450 Typical Scattering Parameters,

$V_{CE} = 3\text{ V}$, $I_C = 50\text{ mA}$

Freq. GHz	S_{11}		S_{21}			S_{12}			S_{22}	
	Mag	Ang	dB	Mag	Ang	dB	Mag	Ang	Mag	Ang
0.1	0.53	-66	31.15	36.115	150	-33.98	0.020	64	0.85	-39
0.5	0.66	-152	23.12	14.327	99	-26.74	0.046	39	0.47	-117
0.9	0.68	-176	18.27	8.197	82	-24.88	0.057	39	0.39	-147
1.0	0.68	-180	17.36	7.376	79	-24.44	0.060	39	0.38	-153
1.5	0.70	165	13.77	4.879	67	-22.38	0.076	40	0.36	-174
1.8	0.70	158	12.15	4.050	60	-21.31	0.086	39	0.36	176
2.0	0.71	153	11.23	3.645	56	-20.72	0.092	38	0.36	171
2.5	0.71	143	9.30	2.919	46	-19.25	0.109	34	0.37	160
3.0	0.72	134	7.77	2.446	37	-17.99	0.126	30	0.38	150
4.0	0.71	116	5.50	1.883	19	-15.92	0.160	18	0.39	133
5.0	0.72	97	3.80	1.548	0	-14.42	0.190	4	0.40	114
6.0	0.75	79	2.28	1.300	-19	-13.47	0.212	-10	0.43	96
7.0	0.78	61	0.84	1.101	-36	-12.92	0.226	-25	0.48	79
8.0	0.80	46	-0.43	0.952	-52	-12.51	0.237	-38	0.52	65
9.0	0.83	31	-1.47	0.844	-68	-12.15	0.247	-52	0.54	51
10.0	0.84	17	-2.43	0.756	-83	-11.90	0.254	-66	0.57	35

HBFP-0450 Noise Parameters: $V_{CE} = 3\text{ V}$, $I_C = 50\text{ mA}$

Freq. GHz	F_{min} dB	Γ_{opt}		$R_N/50$ —	G_a dB
		Mag	Ang		
0.5	1.32	0.43	180	0.13	25.8
0.9	1.44	0.48	-172	0.10	20.9
1.8	1.70	0.61	-151	0.09	15.3
2.0	1.76	0.60	-149	0.11	14.4
2.5	1.90	0.61	-139	0.17	12.5
3.0	2.03	0.64	-130	0.24	11.0
4.0	2.33	0.66	-112	0.50	8.6
5.0	2.61	0.69	-93	0.88	7.0
6.0	2.89	0.73	-75	1.49	5.8

Note: R_N represents normalized noise resistance.

S and noise parameters are measured on a microstrip line made on 0.025 inch thick alumina carrier. The input reference plane is at the end of the base lead, the output reference plane is at the end of the collector lead. S and noise parameters include the effect of four plated through via holes connecting emitter landing pads on the top of test carrier to the microstrip ground plane on the bottom side of the carrier. Two 0.020 inch diameter via holes are placed within 0.010 inch from each emitter lead contact point, one via on each side of that point.

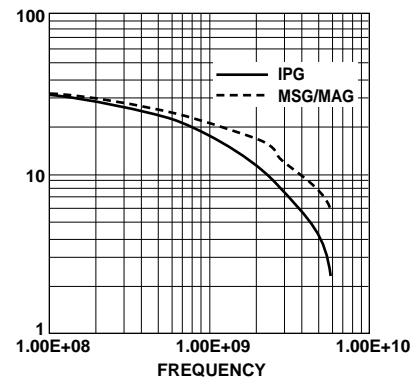

Figure 16. HBFP-0450 Power Gain at 3 V, 50 mA.

HBFP-0450 Typical Scattering Parameters,

$V_{CE} = 3\text{ V}$, $I_C = 80\text{ mA}$

Freq. GHz	S_{11}		S_{21}			S_{12}			S_{22}	
	Mag	Ang	dB	Mag	Ang	dB	Mag	Ang	Mag	Ang
0.1	0.44	-72	31.13	36.031	150	-34.42	0.019	65	0.84	-39
0.5	0.63	-155	23.14	14.355	100	-27.33	0.043	42	0.46	-116
0.9	0.65	-174	18.52	8.429	84	-24.88	0.057	43	0.40	-144
1.0	0.65	-177	17.68	7.659	81	-24.29	0.061	44	0.39	-150
1.5	0.68	171	14.06	5.045	69	-22.16	0.078	44	0.36	-178
1.8	0.68	166	12.34	4.139	64	-21.11	0.088	44	0.36	175
2.0	0.71	152	11.19	3.628	56	-20.63	0.093	39	0.38	169
2.5	0.72	142	9.26	2.905	46	-19.17	0.11	35	0.39	158
3.0	0.72	133	7.73	2.436	37	-17.92	0.127	31	0.39	149
4.0	0.72	115	5.47	1.877	19	-15.81	0.162	19	0.40	131
5.0	0.72	97	3.77	1.543	0	-14.33	0.192	5	0.42	113
6.0	0.75	78	2.25	1.295	-18	-13.39	0.214	-10	0.44	95
7.0	0.78	61	0.80	1.097	-36	-12.84	0.228	-25	0.49	78
8.0	0.80	45	-0.45	0.949	-52	-12.43	0.239	-38	0.53	64
9.0	0.83	31	-1.48	0.843	-67	-12.08	0.249	-52	0.55	50
10.0	0.84	16	-2.45	0.754	-83	-11.87	0.255	-66	0.58	34

HBFP-0450 Noise Parameters: $V_{CE} = 3\text{ V}$, $I_C = 80\text{ mA}$

Freq. GHz	F_{min} dB	Γ_{opt}		$R_N/50$ —	G_a dB
		Mag	Ang		
0.5	1.61	0.58	-177	0.08	25.3
0.9	1.73	0.63	-172	0.07	20.7
1.0	1.76	0.66	-168	0.07	19.9
1.5	1.91	0.70	-162	0.10	16.7
1.8	1.99	0.72	-158	0.09	15.5
2.0	2.06	0.73	-154	0.14	14.4
2.5	2.20	0.74	-147	0.24	12.5
3.0	2.36	0.74	-136	0.34	11.1
4.0	2.65	0.76	-117	0.66	9.1
5.0	2.90	0.77	-94	1.12	7.6
6.0	3.20	0.78	-70	1.89	6.4

Note: R_N represents normalized noise resistance.

S and noise parameters are measured on a microstrip line made on 0.025 inch thick alumina carrier. The input reference plane is at the end of the base lead, the output reference plane is at the end of the collector lead. S and noise parameters include the effect of four plated through via holes connecting emitter landing pads on the top of test carrier to the microstrip ground plane on the bottom side of the carrier. Two 0.020 inch diameter via holes are placed within 0.010 inch from each emitter lead contact point, one via on each side of that point.

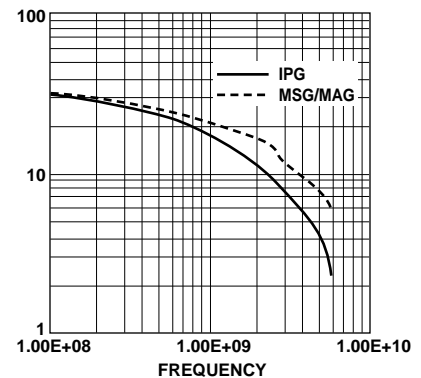
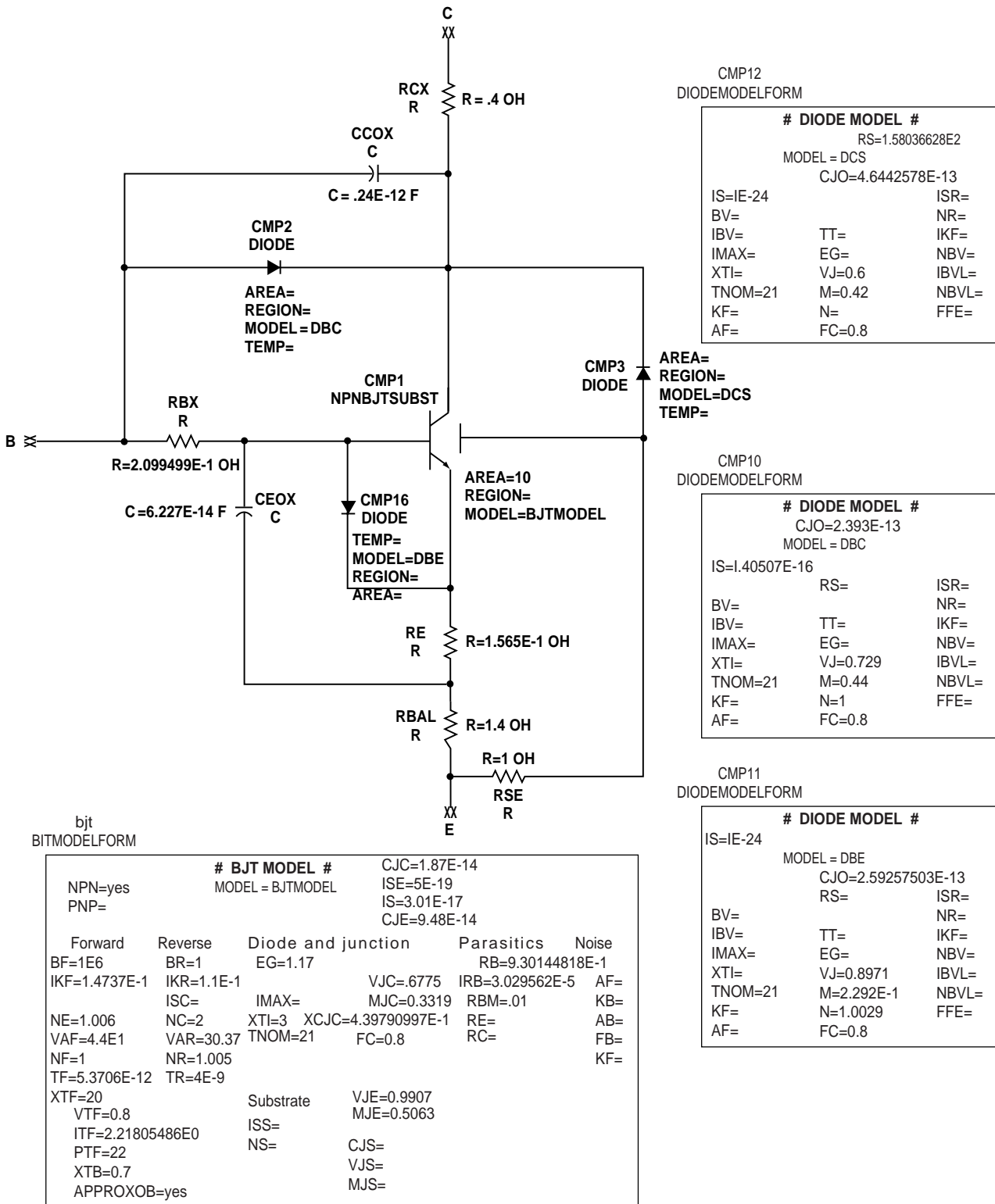

Figure 17. HBFP-0450 Power Gain at 3 V, 80 mA.

HBFP-0450 Die Model and SPICE Parameters



This model can be used as a design tool. It has been tested on MDS for various specifications. However, for more precise and accurate design, please refer to the measured data in this data sheet. For future improvements Hewlett-Packard reserves the right to change these models without prior notice.

SOT343 Package Equivalent Circuit

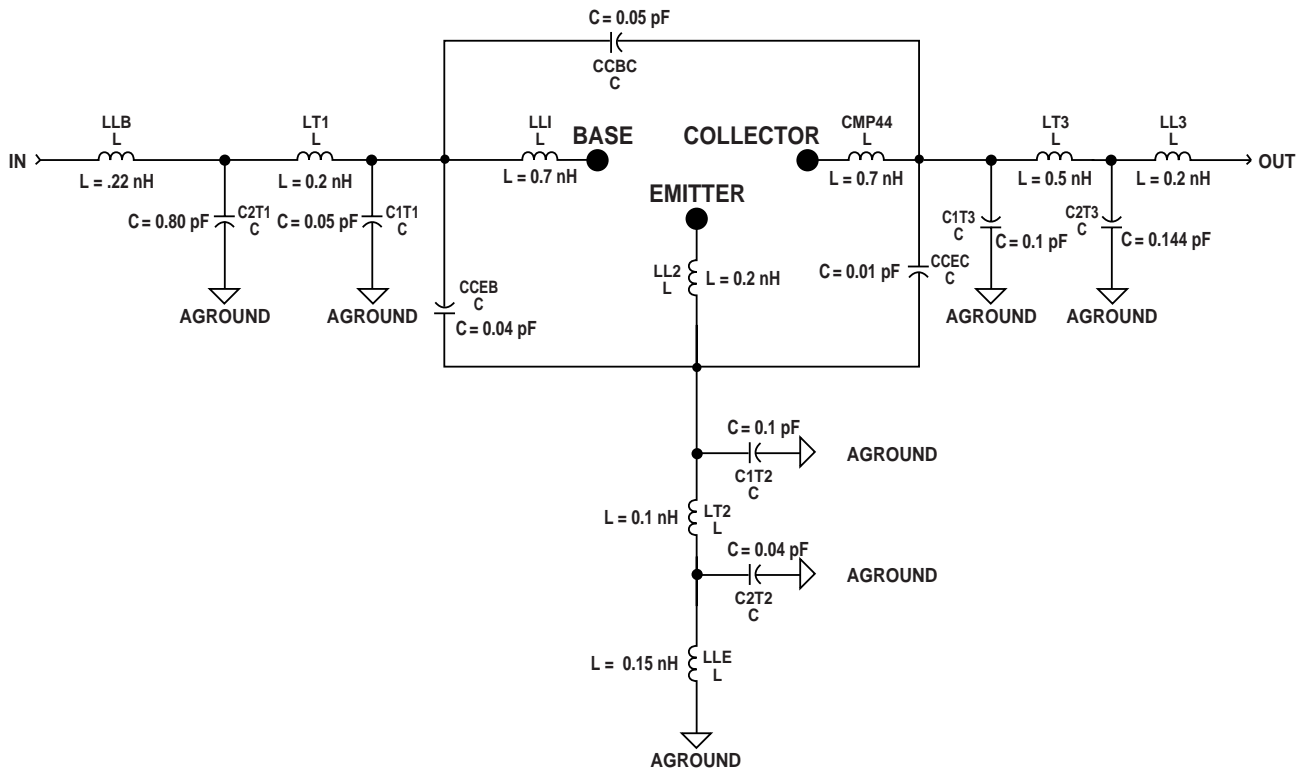

Part Number Ordering Information

Part Number	Devices per Reel	Container
HBFP-0450-TR1	3000	7" Reel
HBFP-0450-TR2	10,000	13" Reel
HBFP-0450-BLK	100	antistatic bag

Package Dimensions

Outline 43, SOT-343 (SC-70 4 Lead)

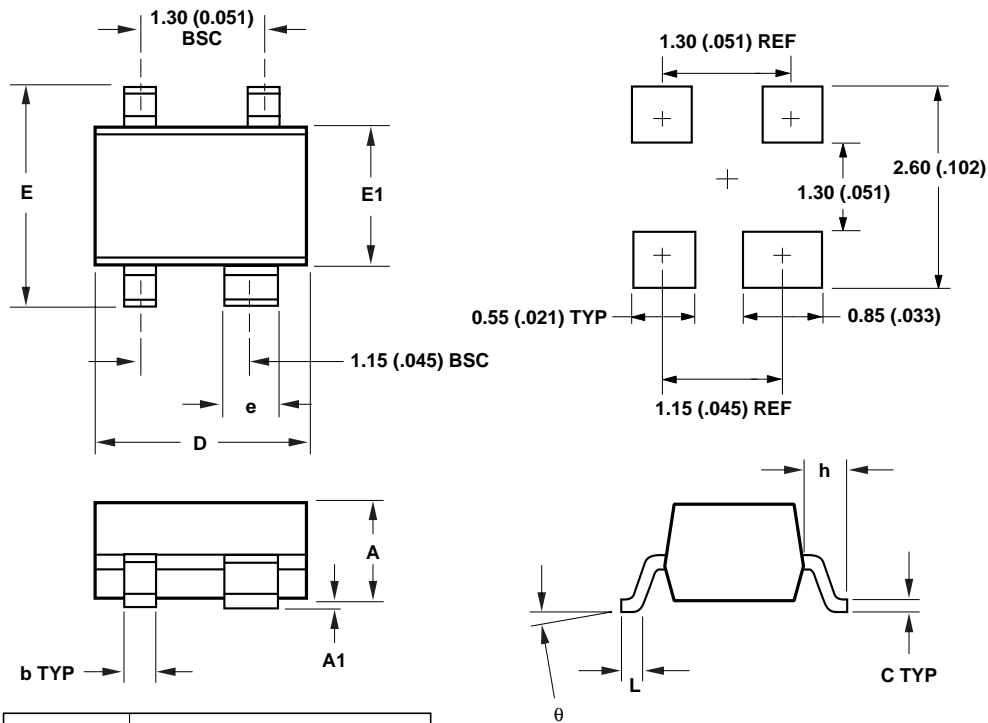

SYMBOL	DIMENSIONS	
	MIN.	MAX.
A	0.80 (0.031)	1.00 (0.039)
A1	0 (0)	0.10 (0.004)
b	0.25 (0.010)	0.35 (0.014)
C	0.10 (0.004)	0.20 (0.008)
D	1.90 (0.075)	2.10 (0.083)
E	2.00 (0.079)	2.20 (0.087)
e	0.55 (0.022)	0.65 (0.025)
h	0.450 TYP (0.018)	
E1	1.15 (0.045)	1.35 (0.053)
L	0.10 (0.004)	0.35 (0.014)
θ	0	10

DIMENSIONS ARE IN MILLIMETERS (INCHES)

Device Orientation

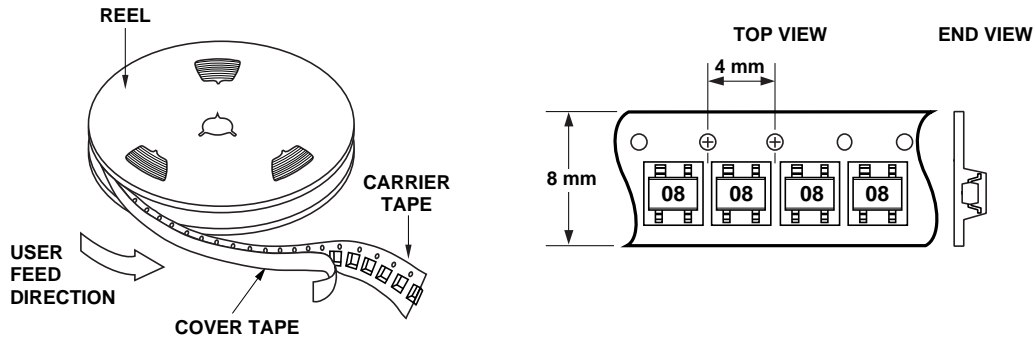

Tape Dimensions For Outline 4T

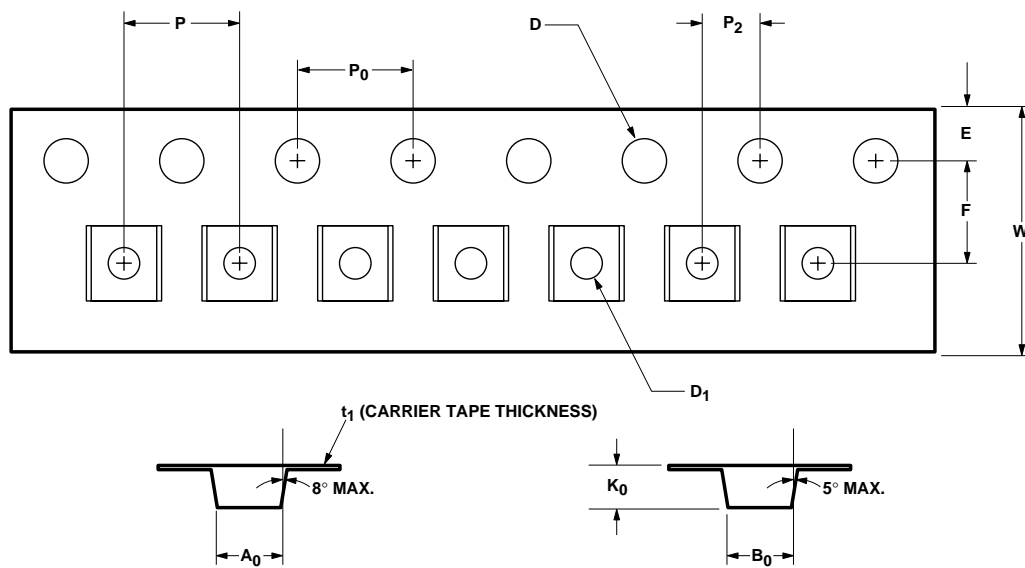

	DESCRIPTION	SYMBOL	SIZE (mm)	SIZE (INCHES)
CAVITY	LENGTH	A_0	2.40 ± 0.10	0.094 ± 0.004
	WIDTH	B_0	2.40 ± 0.10	0.094 ± 0.004
	DEPTH	K_0	1.20 ± 0.10	0.047 ± 0.004
	PITCH	P	4.00 ± 0.10	0.157 ± 0.004
	BOTTOM HOLE DIAMETER	D_1	$1.00 + 0.25$	$0.039 + 0.010$
PERFORATION	DIAMETER	D	1.55 ± 0.05	0.061 ± 0.002
	PITCH	P_0	4.00 ± 0.10	0.157 ± 0.004
	POSITION	E	1.75 ± 0.10	0.069 ± 0.004
CARRIER TAPE	WIDTH	W	8.00 ± 0.30	0.315 ± 0.012
	THICKNESS	t_1	0.259 ± 0.013	0.010 ± 0.0005
DISTANCE	CAVITY TO PERFORATION (WIDTH DIRECTION)	F	3.50 ± 0.05	0.138 ± 0.002
	CAVITY TO PERFORATION (LENGTH DIRECTION)	P_2	2.00 ± 0.05	0.079 ± 0.002



www.hp.com/go/rf

For technical assistance or the location of
your nearest Hewlett-Packard sales
office, distributor or representative call:

Americas/Canada: 1-800-235-0312 or
408-654-8675

Far East/Australasia: Call your local HP
sales office.

Japan: (81 3) 3335-8152

Europe: Call your local HP sales office.

Data subject to change.
Copyright © 1998 Hewlett-Packard Co.

5968-2070E (12/98)