

# Cascadable Silicon Bipolar MMIC Amplifier

## Technical Data

**MSA-0685**

### Features

- **Cascadable 50 Ω Gain Block**
- **Low Operating Voltage:**  
3.5 V Typical  $V_d$
- **3 dB Bandwidth:**  
DC to 0.8 GHz
- **High Gain:**  
18.5 dB Typical at 0.5 GHz
- **Low Noise Figure:**  
3.0 dB Typical at 0.5 GHz
- **Low Cost Plastic Package**

### Description

The MSA-0685 is a high performance silicon bipolar Monolithic Microwave Integrated Circuit (MMIC) housed in a low cost

plastic package. This MMIC is designed for use as a general purpose 50 Ω gain block. Typical applications include narrow and broad band IF and RF amplifiers in commercial and industrial applications.

The MSA-series is fabricated using HP's 10 GHz  $f_T$ , 25 GHz  $f_{MAX}$ , silicon bipolar MMIC process which uses nitride self-alignment, ion implantation, and gold metallization to achieve excellent performance, uniformity and reliability. The use of an external bias resistor for temperature and current stability also allows bias flexibility.

### 85 Plastic Package

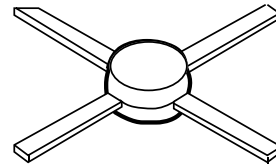

### Typical Biasing Configuration

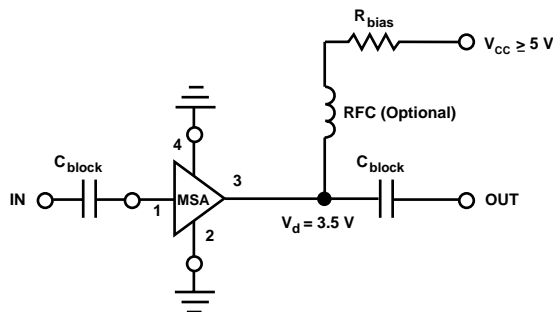

## MSA-0685 Absolute Maximum Ratings

Parameter	Absolute Maximum <sup>[1]</sup>
Device Current	50 mA
Power Dissipation <sup>[2,3]</sup>	200 mW
RF Input Power	+13 dBm
Junction Temperature	150°C
Storage Temperature	-65 to 150°C

**Thermal Resistance<sup>[2,4]</sup>:**

$$\theta_{jc} = 110^{\circ}\text{C}/\text{W}$$

### Notes:

1. Permanent damage may occur if any of these limits are exceeded.
2.  $T_{\text{CASE}} = 25^{\circ}\text{C}$ .
3. Derate at  $9.1 \text{ mW}/^{\circ}\text{C}$  for  $T_{\text{C}} > 128^{\circ}\text{C}$ .
4. See MEASUREMENTS section “Thermal Resistance” for more information.

## Electrical Specifications<sup>[1]</sup>, $T_{\text{A}} = 25^{\circ}\text{C}$

Symbol	Parameters and Test Conditions: $I_{\text{d}} = 16 \text{ mA}$ , $Z_{\text{o}} = 50 \Omega$	Units	Min.	Typ.	Max.
$G_{\text{P}}$	Power Gain ( $ S_{21} ^2$ )	dB	17.0	20.0	
				$f = 0.1 \text{ GHz}$	18.5
$\Delta G_{\text{P}}$	Gain Flatness	dB		$\pm 0.7$	
$f_{3 \text{ dB}}$	3 dB Bandwidth	GHz		0.8	
VSWR	Input VSWR			1.5:1	
	Output VSWR			1.4:1	
NF	50 $\Omega$ Noise Figure	dB		3.0	
$P_{1 \text{ dB}}$	Output Power at 1 dB Gain Compression	dBm		2.0	
$\text{IP}_3$	Third Order Intercept Point	dBm		14.5	
$t_{\text{D}}$	Group Delay	psec		200	
$V_{\text{d}}$	Device Voltage	V	2.8	3.5	4.2
$dV/dT$	Device Voltage Temperature Coefficient	mV/ $^{\circ}\text{C}$		-8.0	

### Note:

1. The recommended operating current range for this device is 12 to 25 mA. Typical performance as a function of current is on the following page.

### MSA-0685 Typical Scattering Parameters ( $Z = 50 \Omega$ , $T_A = 25^\circ\text{C}$ , $I_d = 16 \text{ mA}$ )

Freq. GHz	S <sub>11</sub>		S <sub>21</sub>			S <sub>12</sub>			S <sub>22</sub>		k
	Mag	Ang	dB	Mag	Ang	dB	Mag	Ang	Mag	Ang	
0.1	.04	171	20.1	10.09	171	-22.5	.075	5	.04	-30	1.04
0.2	.02	-180	29.8	9.75	161	-22.4	.076	10	.05	-56	1.04
0.3	.02	-143	19.4	9.38	153	-22.2	.077	15	.07	-76	1.05
0.4	.03	-113	19.1	8.99	145	-21.8	.081	17	.08	-91	1.04
0.5	.05	-105	18.7	8.57	138	-21.3	.086	21	.10	-104	1.04
0.6	.07	-101	18.2	8.14	131	-20.7	.092	25	.11	-116	1.03
0.8	.10	-111	17.3	7.32	119	-19.7	.103	28	.13	-134	1.01
1.0	.13	-118	16.4	6.57	107	-18.8	.115	28	.14	-150	0.99
1.5	.21	-140	14.1	5.06	84	-17.1	.140	28	.15	180	1.00
2.0	.29	-163	12.0	3.98	65	-15.8	.163	26	.16	157	1.02
2.5	.34	-176	10.3	3.26	55	-15.2	.174	28	.16	150	1.06
3.0	.41	169	8.7	2.71	42	-14.8	.181	25	.15	143	1.10
3.5	.46	157	7.2	2.31	30	-14.2	.194	22	.13	144	1.11
4.0	.49	146	6.1	2.01	18	-13.8	.203	20	.10	156	1.13
4.5	.52	135	5.0	1.77	7	-13.4	.215	17	.09	173	1.14
5.0	.54	123	4.1	1.60	-3	-12.9	.226	15	.09	-178	1.14

**Note:**

1. A model for this device is available in the DEVICE MODELS section.

### Typical Performance, $T_A = 25^\circ\text{C}$

(unless otherwise noted)

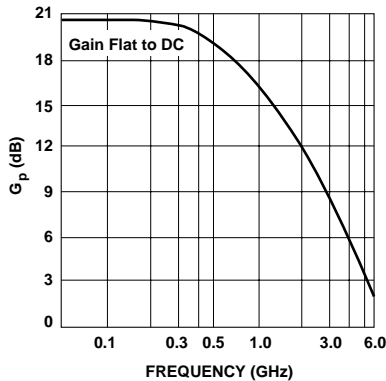

**Figure 1. Typical Power Gain vs. Frequency,  $T_A = 25^\circ\text{C}$ ,  $I_d = 16 \text{ mA}$ .**

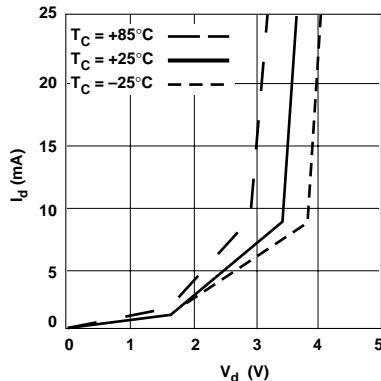

**Figure 2. Device Current vs. Voltage.**

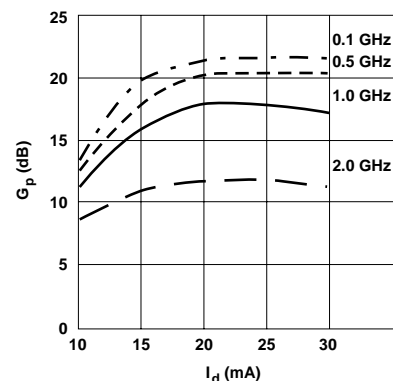

**Figure 3. Power Gain vs. Current.**

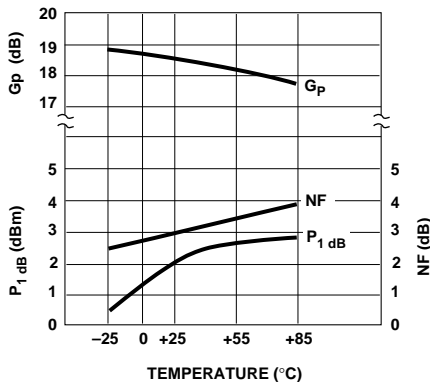

**Figure 4. Output Power at 1 dB Gain Compression, NF and Power Gain vs. Case Temperature,  $f = 0.5 \text{ GHz}$ ,  $I_d = 16 \text{ mA}$ .**

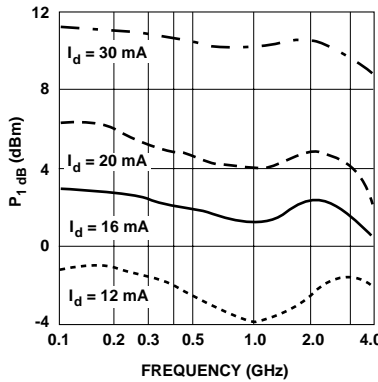

**Figure 5. Output Power at 1 dB Gain Compression vs. Frequency.**

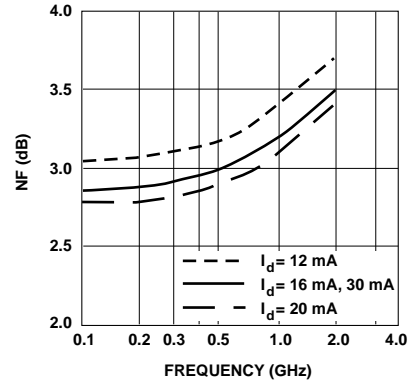

**Figure 6. Noise Figure vs. Frequency.**

# 85 Plastic Package Dimensions

