

# Low Noise, Cascadable Silicon Bipolar MMIC Amplifier

## Technical Data

INA-02170

### Features

- **Cascadable 50 Ω Gain Block**
- **Low Noise Figure:**  
2.0 dB Typical at 0.5 GHz
- **High Gain:**  
31.5 dB Typical at 0.5 GHz  
25.0 dB Typical at 1.5 GHz
- **3 dB Bandwidth:**  
DC to 1.0 GHz
- **Unconditionally Stable**  
( $k > 1$ )
- **Hermetic Gold-Ceramic  
Surface Mount Package**

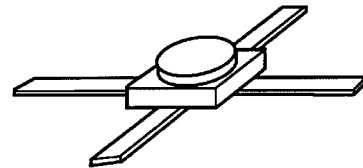
### Description

The INA-02170 is a low noise silicon bipolar Monolithic Microwave Integrated Circuit (MMIC)

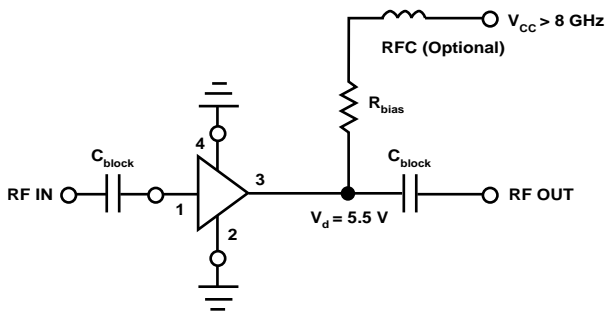
feedback amplifier housed in a hermetic, high reliability package. It is designed for narrow or wide bandwidth industrial and military applications that require high gain and low noise IF or RF amplification.

The INA series of MMICs is fabricated using HP's 10 GHz  $f_T$ , 25 GHz  $f_{MAX}$ , ISOSAT™-I silicon bipolar process which uses nitride self-alignment, submicrometer lithography, trench isolation, ion implantation, gold metallization and polyimide intermetal dielectric and scratch protection to achieve excellent performance, uniformity and reliability.

### 70 mil Package



### Typical Biasing Configuration



### INA-02170 Absolute Maximum Ratings

Parameter	Absolute Maximum <sup>[1]</sup>
Device Current	50 mA
Power Dissipation <sup>[2,3]</sup>	400 mW
RF Input Power	+13 dBm
Junction Temperature	200°C
Storage Temperature	-65 to 200°C

#### Thermal Resistance<sup>[2,4]</sup>:

$$\theta_{jc} = 140^{\circ}\text{C/W}$$

#### Notes:

1. Permanent damage may occur if any of these limits are exceeded.
2.  $T_{\text{CASE}} = 25^{\circ}\text{C}$ .
3. Derate at  $7.1 \text{ mW}/^{\circ}\text{C}$  for  $T_{\text{C}} > 144^{\circ}\text{C}$ .
4. See MEASUREMENTS section "Thermal Resistance" for more information.

### INA-02170 Electrical Specifications<sup>[1]</sup>, $T_{\text{A}} = 25^{\circ}\text{C}$

Symbol	Parameters and Test Conditions: $I_{\text{d}} = 35 \text{ mA}$ , $Z_{\text{O}} = 50 \Omega$	Units	Min.	Typ.	Max.
$G_{\text{P}}$	Power Gain ( $ S_{21} ^2$ ) $f = 0.5 \text{ GHz}$	dB	29.0	31.5	34.0
$\Delta G_{\text{P}}$	Gain Flatness $f = 0.01 \text{ to } 1.0 \text{ GHz}$	dB		$\pm 1.5$	
$f_3 \text{ dB}$	3 dB Bandwidth <sup>[2]</sup>	GHz		1.0	
ISO	Reverse Isolation ( $ S_{12} ^2$ ) $f = 0.01 \text{ to } 1.0 \text{ GHz}$	dB		39	
VSWR	Input VSWR $f = 0.01 \text{ to } 1.0 \text{ GHz}$			1.4:1	
	Output VSWR $f = 0.01 \text{ to } 1.0 \text{ GHz}$			1.5:1	
NF	50 $\Omega$ Noise Figure $f = 0.5 \text{ GHz}$	dB		2.0	2.5
$P_{1 \text{ dB}}$	Output Power at 1 dB Gain Compression $f = 0.5 \text{ GHz}$	dBm		11	
$\text{IP}_3$	Third Order Intercept Point $f = 0.5 \text{ GHz}$	dBm		23	
$t_{\text{D}}$	Group Delay $f = 0.5 \text{ GHz}$	psec		350	
$V_{\text{d}}$	Device Voltage	V	4.0	5.5	7.0
$\text{dV}/\text{dT}$	Device Voltage Temperature Coefficient	$\text{mV}/^{\circ}\text{C}$		+10	

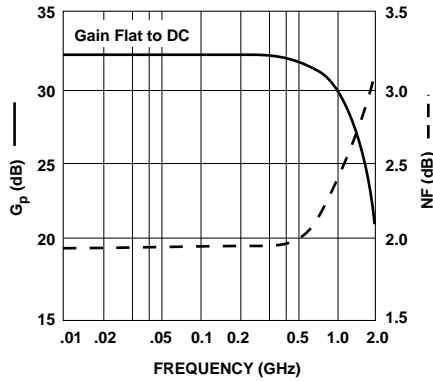
#### Notes:

1. The recommended operating current range for this device is 30 to 40 mA. Typical performance as a function of current is on the following page.
2. Referenced from 10 MHz Gain ( $G_{\text{P}}$ ).

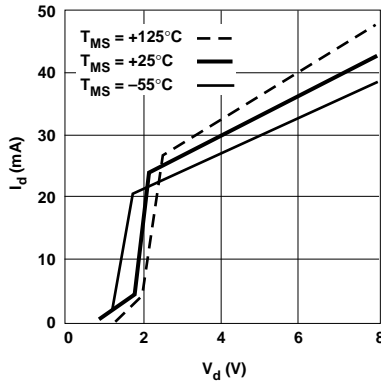
### INA-02170 Typical Scattering Parameters ( $Z_{\text{O}} = 50 \Omega$ , $T_{\text{A}} = 25^{\circ}\text{C}$ , $I_{\text{d}} = 35 \text{ mA}$ )

Freq. GHz	$S_{11}$		$S_{21}$			$S_{12}$			$S_{22}$		k
	Mag	Ang	dB	Mag	Ang	dB	Mag	Ang	Mag	Ang	
0.01	.05	-8	32.5	42.32	-2	-39.2	.011	14	.19	-1	1.26
0.05	.05	-31	32.5	42.32	-7	-38.9	.011	14	.19	-5	1.26
0.10	.06	-85	32.5	42.05	-14	-38.0	.013	10	.19	-10	1.15
0.20	.09	-110	32.3	41.06	-27	-38.8	.011	5	.18	-16	1.29
0.30	.12	-129	32.0	39.82	-40	-38.8	.011	1	.17	-21	1.32
0.40	.15	-140	31.7	38.43	-53	-40.2	.010	19	.16	-25	1.45
0.50	.17	-151	31.4	37.08	-65	-40.0	.010	8	.16	-27	1.48
0.60	.17	-159	31.0	35.49	-77	-39.6	.011	23	.16	-30	1.43
0.80	.18	-174	30.2	32.45	-101	-38.2	.012	23	.16	-40	1.43
1.00	.19	179	29.2	28.70	-126	-38.2	.012	17	.16	-53	1.55
1.20	.19	173	27.8	24.51	-149	-37.5	.013	27	.15	-71	1.66
1.40	.20	166	26.1	20.18	-171	-36.2	.015	35	.14	-102	1.73
1.60	.21	162	24.2	16.26	170	-36.3	.015	34	.12	-172	2.07
1.80	.22	159	22.3	13.02	153	-34.1	.020	46	.10	144	1.94
2.00	.23	155	20.4	10.45	139	-33.0	.022	37	.07	117	2.17
2.50	.25	150	16.7	6.82	112	-33.3	.022	32	.05	95	3.19
3.00	.29	144	13.1	4.51	87	-31.8	.026	32	.04	78	3.96

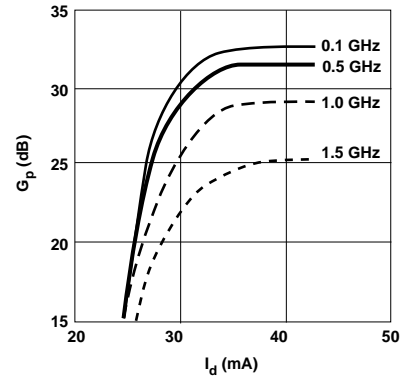
**INA-02170 Typical Performance,  $T_A = 25^\circ\text{C}$**   
(unless otherwise noted)



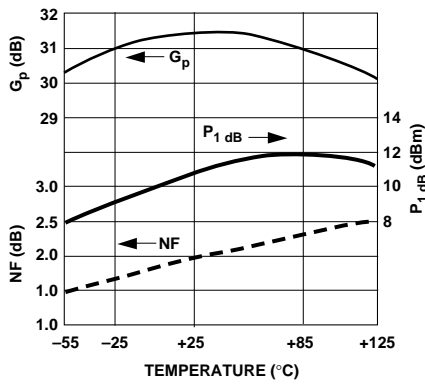
**Figure 1. Typical Gain and Noise Figure vs. Frequency,  $T_A = 25^\circ\text{C}$ ,  $I_d = 35\text{ mA}$ .**



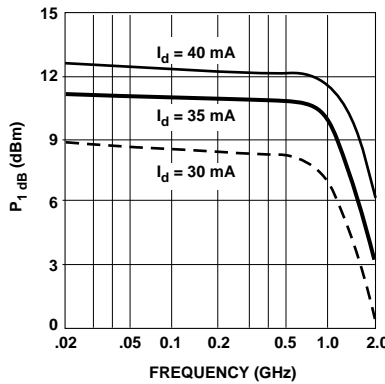
**Figure 2. Device Current vs. Voltage.**



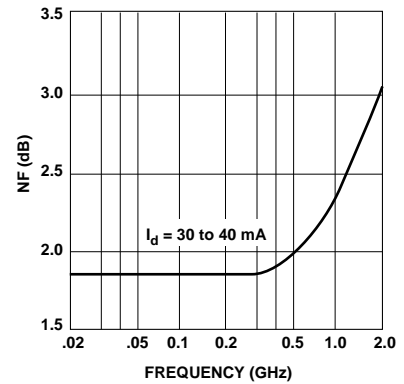
**Figure 3. Power Gain vs. Current.**



**Figure 4. Output Power and 1 dB Gain Compression, NF and Power Gain vs. Case Temperature,  $f = 0.1\text{ GHz}$ ,  $I_d = 35\text{ mA}$ .**

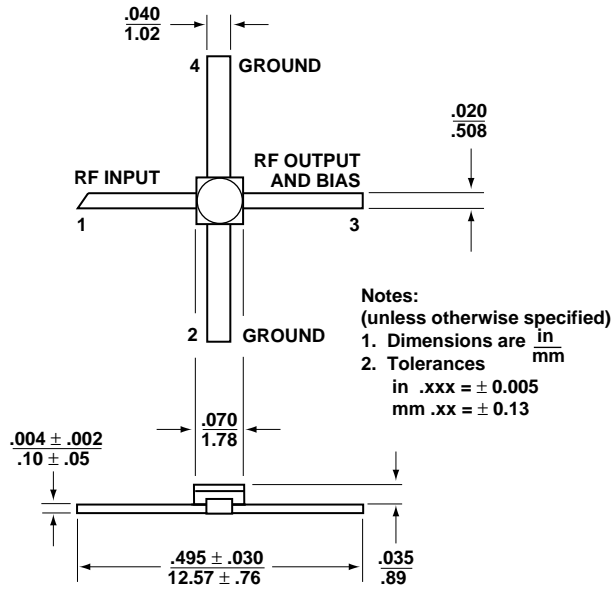


**Figure 5. Output Power at 1 dB Gain Compression vs. Frequency.**



**Figure 6. Noise Figure vs. Frequency.**

## 70 mil Package Dimensions



[www.hp.com/go/rf](http://www.hp.com/go/rf)

For technical assistance or the location of your nearest Hewlett-Packard sales office, distributor or representative call:

**Americas/Canada:** 1-800-235-0312 or 408-654-8675

**Far East/Australasia:** Call your local HP sales office.

**Japan:** (81 3) 3335-8152

**Europe:** Call your local HP sales office.

Data subject to change.  
Copyright © 1998 Hewlett-Packard Co.

Obsoletes 5965-9674E  
Printed in U.S.A. 5966-4957E (5/98)